



Nominal data

Type	4118 NH6	
Nominal voltage	VDC	48
Nominal voltage range	VDC	36 .. 60
Speed (rpm)	min ⁻¹	8400
Power consumption	W	62
Min. ambient temperature	°C	-20
Max. ambient temperature	°C	65
Air flow	m ³ /h	440
Sound power level	B	8.1
Sound pressure level	dB(A)	73

ml = Max. load · me = Max. efficiency · fa = Free air · cs = Customer specification · ce = Customer equipment
Subject to change

Technical description

General description	* Power consumption when wide open; these values may be considerably higher at the operating point.
Impeller material	Glass-fiber reinforced PA plastic
Weight	0.390 kg
Dimensions	119 x 119 x 38 mm
Housing material	Die-cast aluminum
Airflow direction	Intake over struts
Direction of rotation	Clockwise, viewed toward rotor
Storage	Ball bearing
Service life L10 at 40 °C	60000 h
Service life L10 at maximum temperature	32500 h
Cable	Leads AWG 22, UL 1007, TR 64, stripped and tin-plated.
Motor protection	Protection against reverse polarity and blocked rotor.
Approval	VDE, CSA, UL
Option	Speed signal

Product drawing

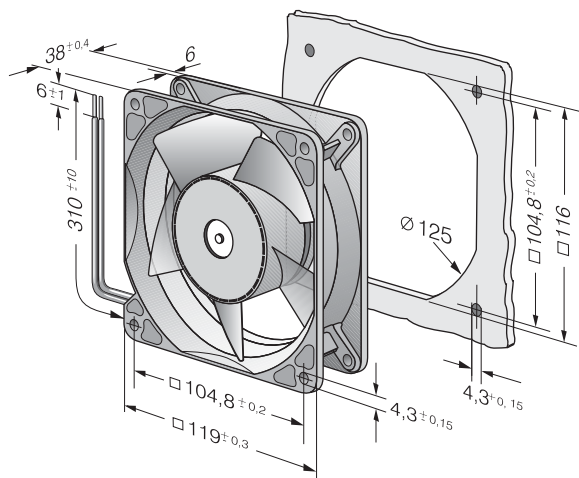

Curves: Air performance

